



XV22DVR

USER MANUAL



For more information
on the Xview range go
to our website

xviewdrive.com.au



INCLUSIONS:

Dash Cam, GPS Power Cable, 12/24V In-Car USB Charger,
Micro SD Card, Adhesive Surface Mount, Rear Camera &
Rear Camera Cable.

1. PRODUCT PICTURE AND FUNCTION

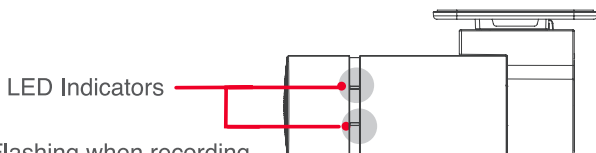
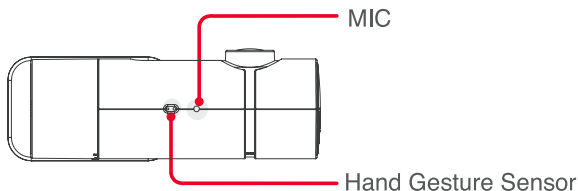
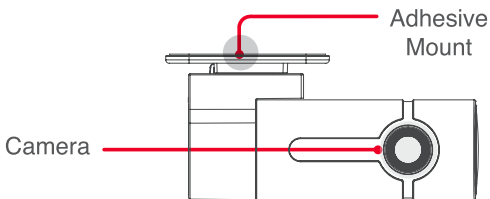

Red: Flashing when recording
Green: Mobile phone connected

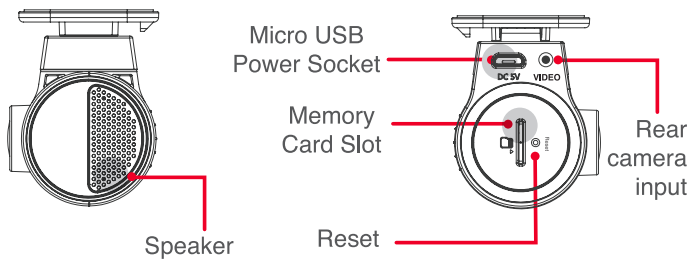

2. INSTALLING THE DASH CAM

1. Insert Micro SD card

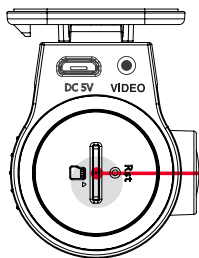

Car camera supports up to 64GB TF card, and Class 10 TF card is required.

Memory Card Slot

2. Mounting

2.1 Check the orientation of the Dash Cam camera first before installation. When the Dash Cam lens is facing outwards, the Hand Gesture Sensor faces down.

2.2 Use an Alcohol wipe to clean the windscreen and enhance adhesion.

2.3 Fix the Dash Cam on the inside surface of the windscreen by removing backing off 3M tape and press & hold firmly to windscreen for 60 seconds. The area near the rear-view mirror is suggested where the vision is not blocked. Do not install the device on the vehicles airbag or within its working range.

2.4 Insert the Micro USB end of the GPS power cable into the Micro USB Power socket/ charging point of the Dash Cam. Fix the GPS power cable on the inside surface of the windscreen by removing backing off 3M tape and press & hold firmly to windscreen for 60 seconds. For a better GPS signal, make sure the 3M sticker faces toward the sky and is not blocked or obstructed. Connect USB charging end of the GPS power cable into the 12/24V In-car USB charger, then plug this into 12/24V power socket of vehicle.

2.5 Turn the vehicles ignition on and the Dash Cam will power ON and start recording automatically, you will hear an audible confirmation.

2.6 When recording the LED light indicator will flash red.

2.7 For the Dash Cam to work it must receive power from the charging adapter. Once power is removed or turned off the Dash Cam will save the current file and turn off.

NOTE: *The Dash Cam power cable must be used to retain date and time settings.*

2.8 Rotate the camera direction to get the best view.

2.9 Once position of the camera is OK hide the cable like the positioning diagram below.

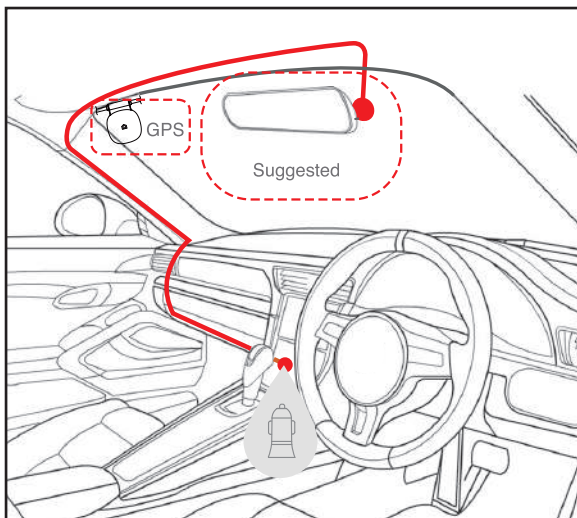

3. INSTALLING THE REAR CAMERA

3.1. Insert the rear camera cable into the video input of the Dash Cam and test the orientation of the camera for recording.

3.2. Then run the cable to the rear cameras location.

3.3. Fix the cable along the ceiling or A-pillar where it can be safely hidden. (Drivers side see picture below)

3.4. Then mount the rear camera to the inside of the vehicles window, with the cable input facing the drivers side.

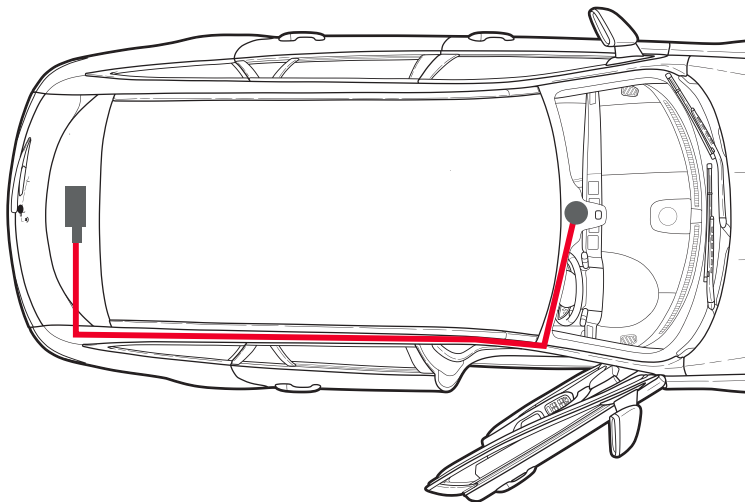

4. CONNECTING TO WIFI

Recording video, taking photos, live streaming, GPS data, download files and changing Dash Cam settings can all be done via WiFi and downloading the 'XV22' Xview Dash Cam APP. For iPhones search the APP Store or for Android devices via Google Play.

4.1 Power up your Dash Cam

4.2 Make sure that you have your "**LOCATION**" turned on, and your "**MOBILE DATA**" turned off in the settings of your smartphone.

4.3 To pair the Dash Cam with your smartphone, go into the settings menu on your smartphone and turn WiFi on to and display all devices for connection.

4.4 Select your Dash Cam model SSID name example: (XV22DVR-XXXX).

4.5 Enter the password 12345678.

4.5 Once successfully paired to your DASH CAM the Dash Cam will give you a voice confirmation.

4.6 Once connection is successful, the indicator light on the side of your Dash Cam turns green.

4.7 After your initial pairing of your device to the Dash Cam's WiFi network you can turn back on your mobile data. For all future pairing you do not need to disable your mobile data. However, if you have an issue that looks as if the phone cannot get data from the device you may try disabling mobile data as a possible remedy.

5. USING THE APP

5.1 Then launch the “XV22’ Xview Dash Cam APP on your smartphone to pair with the Dash CAM. On the home screen select the wording “PAIR” or “CONNECT” depending on your device. Once paired you will have access functions and settings of the Dash Cam.



5.2 The App viewer screen should look like image below.



5.3 When in portrait mode a live image of the Dash Cam's view will be displayed at the top of the phone screen. Use this image to adjust the angle of the camera so that the lower part of the cameras view can see the end of the cars bonnet (about ¼ of its length)

5.4 To take a picture, press the white button in the lower centre of your screen

5.5 To access your Dash Cam videos, press the video camera icon in the lower centre of your screen

5.6 To access the Dash Cam's settings, press the settings gear icon in the lower centre of your screen

5.7 To view your files via the APP, click on the video icon on the viewer screen. Select the recorded video file you wish to view under the appropriate heading.

Normal/ Clips/Event/Parking. This will open up the playback screen and start playing the recorded video.

5.8 Select the downloading icon and the selected file will download from the DASH CAM to your Smartphone for viewing. Alternatively press the wording 'select', in the top right corner. Click on individual files and press the download arrow icon. You can also remove the SD card from the Dash Cam and plug the card directly into your computer to access files.

6. USING GPS FUNCTION

6.1 To use the GPS function, the GPS antenna module must be plugged into the Dash Cam.

6.2 The GPS data is automatically saved into the video files. In order to view the GPS data using the mobile phone APP, you need to download the video file in the Dash Cam to your mobile phone. As mentioned in point 5.8 on page 9.

6.3 Disconnect from the Dash Cam WiFi and go back into App to view files and GPS Data on your phone.

6.4 Click on the Gallery Icon at the bottom of the App home screen to display video file with GPS data.

6.5 Click on the GPS Log icon at the bottom of the App home screen to view more video tracking information and map data.

6.6 You can also download a free GPS player from our website for your computer to display GPS data. Search for your model and download the GPSPlayer viewer.

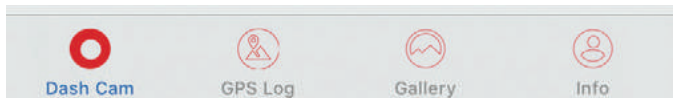

7. HAND GESTURE PHOTO FUNCTION

Whilst recording you can wave your hand in front of the hand gesture sensor, the Dash Cam will make a click sound and automatically takes a photo. It will also capture and save 10 seconds of the current recorded video, 5 seconds before and 5 seconds after hand gesture initiation.

8. G-SENSOR FUNCTION (Conflict sensitivity)

G-sensor Sensitivity: High, Medium, Low Sensitivity or Shutdown (Turn off) is available. This function activates in the case of a car accident. When this function activates the Dash Cam will automatically sync a 10 second video clip and save it to the Event folder on the SD card. We recommend Low Sensitivity to avoid false triggers.

Note: With this function turned on it may fill up the SD card with locked video files. Re-format the SD card to create space. The device does NOT guarantee video recording of all accidents as built-in impact sensor may not be activated due to combination of user settings and the level of impact during the collision.

9. PARK MODE FUNCTION (Parked vehicles surveillance)

After 10 minutes of the vehicle being parked. An audio message will announce “in park mode”. It will start recording 10 second video footage when motion triggered. When ignition is turned on park mode turns off and the Dash Cam will return to continuous recording. (Requires installation with optional XVIEW Hard Wire Kit (XVHWC) Sold separately.

10. FORMATTING SD CARD (Manage the TF Card)

It is advisable to format the card weekly if you have the Gravity Sensing (Gsensor) setting turned on, or create locked files. This will fill up the card causing it to stop recording any footage.

11. FACTORY RESET

To hard reset the device back to its original settings in the case of a system jam or crash. Insert a fine point paper clip into the reset hole next to Memory card slot.

12. BACKING UP RECORDED DATA

Remove SD Card from the Dash Cam and use a reader connected to a computer to access files and folders.

13. SPECIFICATION

CPU: MSC8328Q

Image sensor: Omnivision 2718

Battery: Super capacitor

Front/Rear Video information: 1920*1080P(16:9), @30fps, *MOV

Video event information: 1920*1080(16:9), @30fps, *.MP4

Photo information: JPG

Storage: Supports Micro SD Card Class10 up to 64GB

Front Viewing Angle: 152°Wide Angle

Rear Viewing Angle: 120°Wide Angle

Functions: WiFi 2.4GHz, 802.11b/g/n, GPS, G-Sensor, Loop recording & Parking Monitor

Audio: Built-in Microphone and speaker

OSD Language: English

Input / Output: Micro USB (Power)

Input/Output: USB Micro (Power) / 2.5mm (Camera)

In-Car USB Charger: 12 or 24V

14. TROUBLE SHOOTING

Problem: The adhesive mount will not stay attached to the windscreen

Solution: • Ensure windscreen is clean and free of debris, use glass cleaner or an alcohol swab to clean.

- Ensure that the plastic film has been removed from the adhesive pad.
- When mounting hold the bracket firmly to the windscreen for at least 60 seconds.

Problem: The Dash Cam will not power on

Solution: • Vehicle Accessory Socket - Check the vehicle accessory socket has power, simply plug another device and see if it powers up (or use a test light / multimeter to check for power).

- Dash Cam Power Cable - Check the fuse in the tip of the accessory plug, it may need to be replaced.
- Dash Cam - Connect the Dash Cam to a computer via the USB cable to see if it powers up.

Problem: The Dash Cam shuts down when connected to the vehicle and the battery will not charge

Solution: • This dash cam does not have a battery, it has a Super Capacitor.

- The dash cam will only turn on when the vehicle is switched on.

Problem: The Dash Cam battery only lasts for a few minutes when power is disconnected

Solution: • This dash cam does not have a battery, it has a Super Capacitor.

- The Super Capacitor only holds enough power to safely shut down the dash cam, securely save the last file when power is disconnected and retain settings.
- The Dash Cam is designed to be connected to power at all times while being used.

Problem: The WiFi does not seem to be connecting / the Dash Cam won't connect with my phone

Solution: • Ensure WiFi is switched on in your mobile settings and select your Dash Cam from the device list.

- Make sure you have entered the correct password for the device (12345678).
- If the device is still not connecting correctly, forget the Dash Cam from the phone through the settings, reset the Dash Cam, restart the mobile phone, and then try again.
- Check your phone has the latest software update and also check the App has been updated with the latest version.

Problem: The Dash Cam feels warm when it is operating

Solution: • It is normal for the Dash Cam to feel warm to the touch during typical use, especially when it is recording HD video.

Problem: The Dash Cam stops automatically while recording

Solution: • Check to see whether there is enough space on the Micro SD card.

- Ensure correct Micro SD card is being used, 8-64Gb Class 10 or above Micro SDHC/XC is recommended.

Other types of Micro SD cards may not be suitable for use in Dash Cams.

- If the correct Micro SD Card is being used, format the Micro SD Card in a computer.
- Micro SD cards have a limited lifespan and become corrupt after a period of time. This is due to the continuous loop recording function. If this has occurred, you will need to replace you Micro SD Card.

Problem: The Micro SD card is not recognised by the Dash Cam

Solution: • Format the Micro SD card before using. Be sure the Micro SD card is compatible with the device, see “Stops automatically while recording” fault.

Problem: The Dash Cam will not record video or take pictures

Solution: • Check to see whether there is enough space on the Micro SD card. If not, the Micro SD card will need to be formatted.

Problem: Video files can not be played on the PC

Solution: • The video files from the Dash Cam are in .MP4 format and may not be compatible with your PC if suitable playback software is not installed.

Problem: My videos are blurry, dirty or discoloured

Solution: • Check to see if there are any finger prints or dirt present on the Dash Cam lens. If needed, clean with a soft dry cloth before recording.

• Also be sure to have removed the transparent lens cover during installation.

Problem: The Dash Cam is frozen or not responding

Solution: • Reset the unit by inserting a pin into the reset hole, push and hold the reset button for a few seconds and try again.

• Format Micro SD Card in a computer.

Problem: Unresolved issues

Solution: • Reset the unit by inserting a pin into the reset hole, push and hold the reset button for a few seconds and try again.

• Format Micro SD Card in a computer.

• Contact Xview Technical Department

15. SAFETY INFORMATION & WARNINGS

Do not use the Dash Cam in damp working conditions; the Dash Cam is not waterproof.

Do not try opening the shell or trying to repair the Dash Cam by yourself. If the accessories for the Dash Cam have any problems, please take it to an authorised repair agent for repair.

Do not use a chemical substance, cleaning solvent or cleaner to clean the Dash Cam, please use a moist soft cloth if you would like to clean the Dash Cam.

Do not use the Dash Cam under conditions where dust is present.

Use a moist soft cloth to clean the lens before use, to avoid poor video footage.

Xview is NOT responsible for the loss of any recorded video during operation. Although designed to withstand high impact of car collision.

Xview does NOT guarantee recording of accidents where the impact may cause the device to be damaged.

18. USER SUPPORT

If you need assistance setting up or have an issue regarding the use of your Xview product contact Xview Customer Support. Australian Agent:

TEL: 03 – 8587 8898 FAX: 03 – 8587 8866

Mon-Fri 9am – 5pm AEST

For more information, manuals, software or other products in the Xview range please go to our website.

Xviewdrive.com.au

This manual is considered correct at time of printing but is subject to change. For latest manuals and updates refer to the website.

Please retain this user guide for future reference.